

Design Elements Collection

DOOR STYLE SELECTIONS





Home is our place for rest and comfort, for joy and memories. As we tailor our homes to suit the needs of our families, they become a reflection of who we are.

Because cabinetry is such an integral part of our homes, Bishop Cabinets makes each cabinet to order so that you can structure your living spaces to best suit your particular needs. But cabinetry is about more than just structure, it is also about beauty. The combinations of wood species, door styles and finishes that you will find within these pages will give you literally hundreds of thousands of possibilities, so that you can create that fashion which perfectly defines you.

In this booklet you'll find door styles from our Design Elements Collection, which features custom-tailored doors. These door styles allow you to combine your choices of wood specie, door and drawer front type to create one-of-a-kind fashions.

The possibilities are limited only by your imagination. The images shown on the following pages are only a small taste of those possibilities. After you've spent some time pondering what you might like, we invite you to visit your Bishop dealer to select your perfect style.

Inset Door Styles *for Framed Cabinetry*

Garden Home

Applied Molding Slab

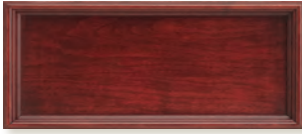

Wood Shown
Cherry

Woods Offered
All Domestic
Woods

Finish Shown
Pinot Noir stain

Doors
All Square

Drawer Fronts
Applied Molding
Slab shallow.
Raised Panel deep

2 1/4" Door Stiles

Grand Isle

Applied Molding Slab



Wood Shown
Maple

Woods Offered
All Domestic
Woods

Finish Shown
Brilliant White
Paint

Doors
All Square

Drawer Fronts
Applied Molding
Slab shallow
Reverse Raised
Panel deep

2 1/4" Door Stiles

Long Beach

Applied Molding Slab

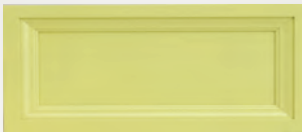

Wood Shown
Maple

Woods Offered
Cherry, Maple,
Oak

Finish Shown
Custom Paint

Doors
All Square

Drawer Fronts
Applied Molding
Slab for shallow
& deep

3" Door Stiles

New Ashford

Slab



Wood Shown
Cherry

Woods Offered
All Domestic
Woods

Finish Shown
Custom stain

Doors
All Square

Drawer Fronts
Slab shallow
Reverse Raised
Panel deep

2 1/4" Door Stiles

Inset Door Styles *for Framed Cabinetry*

Old Town

Slab

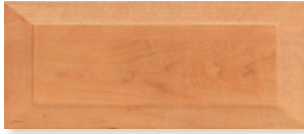

Wood Shown
Maple

Woods Offered
All Domestic
Woods

Finish Shown
Light stain

Doors
All Square

Drawer Fronts
Slab shallow
Raised Panel deep

2 1/4" Door Stiles

South Hampton

Slab

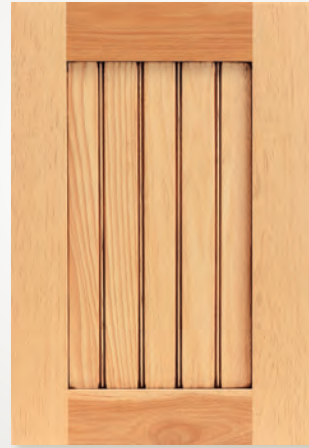
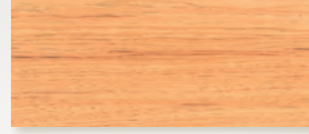

Wood Shown
Hickory

Woods Offered
All Domestic
Woods

Finish Shown
Natural finish with
Chocolate glaze

Doors
All Square

Drawer Fronts
Slab shallow
Grooved Reverse
Raised Panel deep

2 1/4" Door Stiles

St Cloud

Slab



Wood Shown
Maple

Woods Offered
Cherry, Maple,
Oak

Finish Shown
Custom stain
with Black burnish

Doors
All Square

Drawer Fronts
Slab shallow
Reverse Raised
Panel deep

2 1/4" Door Stiles

Van Buren

Slab

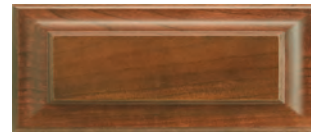

Wood Shown
Cherry

Woods Offered
All Domestic
Woods

Finish Shown
Cinnamon stain

Doors
All Square

Drawer Fronts
Slab shallow
Raised Panel deep

2 1/4" Door Stiles

Inset Door Styles *for Framed Cabinetry*

Beaded Frame Option



When an inset door style is used, cabinet face frames can be beaded as shown in the photo to the left.

When attempting to recreate the look of dark-stained antique furniture, it is often better not to bead the frames, as shown in the photo to the right.

Beaded frames are recommended with painted finishes as shown in the photo below.



New Ashford door style in Cherry with Custom stain and Black glaze



*New Ashford door style in Maple with Offwhite paint
Image compliments of Details by Design*

Full Overlay Door Styles *for Framed and Full Access Cabinetry*

Avon Park



Square



Cathedral



Arch



Slab



4/4



Raised Panel

The Avon Park door style features 2 1/4" stiles and rails with raised panels and offers several wood species, door and drawer front options.

Wood Shown
Cherry

Available Woods
All Domestic Wood Species

Finish Shown
Custom stain

Lower Doors
Square

Upper Door Choices
Square, Arched, Cathedral

Drawer Front Choices
Slab, 4/4, Raised Panel

Bar Harbor



Square



Cathedral



Arch



Slab



4/4



Raised Panel

The Bar Harbor door style features 2 1/4" stiles and rails with raised panels and offers several wood species, door and drawer front options.

Wood Shown
Maple

Available Woods
All Domestic Wood Species

Finish Shown
Custom base coat with Oyster glaze

Lower Doors
Square

Upper Door Choices
Square, Arched, Cathedral

Drawer Front Choices
Slab, 4/4, Raised Panel

Full Overlay Door Styles *for Framed and Full Access Cabinetry*

Fair Haven



Square



Cathedral



Arch



Slab



4/4



Raised Panel

The Fair Haven door style features 3" stiles and rails with raised panels and offers several wood specie, door and drawer front options.

Wood Shown
Maple

Available Woods
All Domestic Wood Species

Finish Shown
Amber stain

Lower Doors
Square

Upper Door Choices
Square, Arched, Cathedral

Drawer Front Choices
Slab, 4/4, Raised Panel

Pleasant Brook



Square



Cathedral



Arch

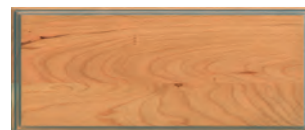

Slab

The Pleasant Brook door style features 2 1/4" stiles and rails with reverse raised panels and offers several wood specie, door and drawer front options.

Wood Shown
Rustic Cherry

Available Woods
All Domestic Wood Species

Finish Shown
Natural finish with Oyster glaze

Lower Doors
Square

Upper Door Choices
Square, Arched, Cathedral

Drawer Front Choices
Slab

Full Overlay Door Styles *for Framed and Full Access Cabinetry*

Cape Cod

Slab



Reverse Raised Panel



Wood Shown
Oak

Woods Offered
All Domestic Woods

Finish Shown
Custom base coat with
Edgewear & Distress

Doors
All Square

Drawer Fronts
Choose Slab or
Reverse Raised Panel

3" Door Stiles

Coral Gables

Reverse Raised Panel



Wood Shown
Oak

Woods Offered
Cherry, Maple,
Oak

Finish Shown
Offwhite base coat
with Oyster glaze

Doors
Square

Drawer Fronts
Reverse Raised Panel

2 1/2" Door Stiles

Cottage Grove

Slab



Wood Shown
Knotty Alder

Woods Offered
All Domestic Woods

Finish Shown
Natural finish
with Mocha
glaze

Doors
All Square

Drawer Fronts
Slab

Downey Lane

Slab

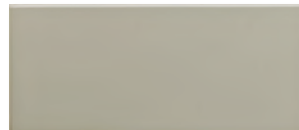

Reverse Raised Panel



Wood Shown
Maple

Woods Offered
All Domestic Woods

Finish Shown
Ellie Gray Paint

Doors
All Square

Drawer Fronts
Choose Slab or
Reverse Raised Panel

3" Door Stiles

Full Overlay Door Styles for Framed and Full Access Cabinetry

East Windsor

Slab



Reverse Raised Panel



Wood Shown
Maple

Woods Offered
All Domestic Woods

Finish Shown
Black base coat with Edgewear

Doors
All Square

Drawer Fronts
Choose Slab or Reverse Raised Panel

3" Door Stiles

Fifth Avenue

Raised Panel



Wood Shown
Cherry

Woods Offered
Cherry, Maple, Oak

Finish Shown
Medium stain with Black glaze

Doors
All Square

Drawer Fronts
Raised Panel

3" Door Stiles

Fort Myers

Slab



Reverse Raised Panel



Wood Shown
Cherry

Woods Offered
All Domestic Woods

Finish Shown
Medium stain

Doors
All Square

Drawer Fronts
Choose Slab or Reverse Raised Panel

3" Door Stiles

Hilton Head

Reverse Raised Panel



Wood Shown
Maple

Woods Offered
All Domestic Woods

Finish Shown
Espresso stain

Doors
All Square

Drawer Fronts
Reverse Raised Panel

3" Door Stiles

Full Overlay Door Styles for Framed and Full Access Cabinetry

Klamath Falls

Slab

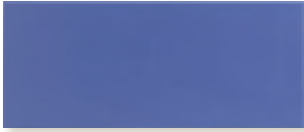

Reverse Raised Panel



Wood Shown
Maple

Woods Offered
All Domestic Woods

Finish Shown
Custom Paint

Doors
Square

Drawer Fronts
Choose Slab or
Reverse Raised Panel

3 1/2" Door Stiles

Lafayette Square

Raised Panel



Wood Shown
Maple

Woods Offered
Cherry, Maple,
Oak

Finish Shown
Custom base coat
with Mocha glaze

Doors
Square

Drawer Fronts
Raised Panel

2 1/2" Door Stiles



Garden Home door style in Cherry with Medium stain and Black glaze

Full Overlay Door Styles *for Framed and Full Access Cabinetry*

Lake Wales

Reverse Raised Panel



Wood Shown
Cherry
Woods Offered
Cherry, Maple,
Oak
Finish Shown
Pinot Noir stain
with Black burnish
Doors
All Square
Drawer Fronts
Reverse Raised
Panel
3" Door Stiles

Mount Shasta

Reverse Raised Panel



Wood Shown
Cherry
Woods Offered
Cherry, Maple,
Oak
Finish Shown
Light stain
Doors
All Square
Drawer Fronts
Reverse Raised
Panel
2 1/2" Door Stiles

Mount Vernon

Slab

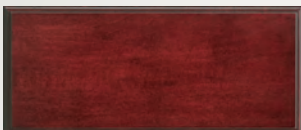

Raised Panel



Wood Shown
Maple
Woods Offered
All Domestic Woods
Finish Shown
Pinot Noir stain
Doors
Square
Drawer Fronts
Choose Slab or
Raised Panel
3 3/16" Door Stiles

Napa Valley

Slab

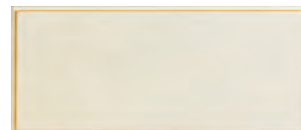

Reverse Raised Panel



Wood Shown
Maple
Woods Offered
All Domestic Woods
Finish Shown
Brilliant White base coat
with Chocolate glaze
Doors
All Square
Drawer Fronts
Choose Slab or
Reverse Raised Panel
3" Door Stiles

Full Overlay Door Styles *for Framed and Full Access Cabinetry*

North Andover

Slab

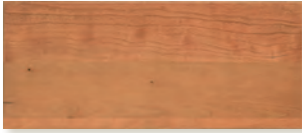

Reverse Raised Panel

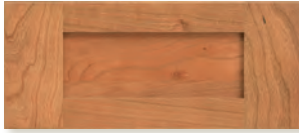

Wood Shown
Cherry
Woods Offered
All Domestic Woods
Finish Shown
Light Stain
Doors
Square
Drawer Fronts
Choose Slab or
Reverse Raised Panel
2 1/4" Door Stiles

Park City

Slab



Reverse Raised Panel



Wood Shown
Cherry
Woods Offered
All Domestic Woods
Finish Shown
Obsidian Stain
Doors
All Square
Drawer Fronts
Choose Slab or
Reverse Raised Panel
3" Door Stiles

Punta Cana

Slab

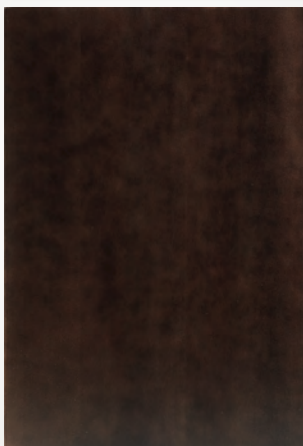
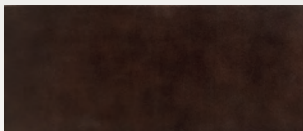

Wood Shown
Maple
Woods Offered
Cherry, Maple
Finish Shown
Espresso stain
Doors
Slab Veneer,
plain sliced, not
book matched
Drawer Fronts
Slab Veneer,
plain sliced, not
book matched

San Francisco

Pillowtop Slab



Wood Shown
Cherry
Woods Offered
Cherry, Maple
Finish Shown
Cinnamon stain
Doors
Pillowtop Veneer,
plain sliced, not
book matched
Drawer Fronts
Pillowtop Veneer,
plain sliced, not
book matched

Full Overlay Door Styles *for Framed and Full Access Cabinetry*

Ventura Way

Raised Panel



Wood Shown
Maple

Woods Offered
Cherry, Maple,
Oak

Finish Shown
Custom base coat
with Chocolate
glaze

Doors
All Square

Drawer Fronts
Raised Panel

3" Door Stiles

Walden Pond

Recessed Panel



Wood Shown
Maple

Woods Offered
Maple

Finish Shown
Chestnut stain

Doors
All Square

Drawer Fronts
Recessed Panel

2 1/2" Door Stiles

Warm Springs

Reverse Raised Panel



Wood Shown
Maple

Woods Offered
Cherry, Maple, Oak

Finish Shown
Natural finish
with Mocha glaze

Doors
Square

Drawer Fronts
Reverse Raised
Panel

2 1/2" Door Stiles



*Bar Harbor door style
in Maple with Chalk paint*

1/2" Overlay Door Styles for Framed Cabinetry

Castle Glen



Square



Cathedral



Arch

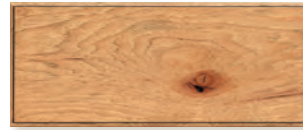

Slab

The Castle Glen door style features 2 1/4" stiles and rails with raised panels and offers several door and wood specie options.

Wood Shown
Rustic Hickory

Available Woods
All Domestic Wood
Species

Finish Shown
Light stain with Mocha
glaze

Lower Doors
Square

Upper Door Choices
Square, Arched,
Cathedral

Drawer Fronts
Slab

2 1/4" Door Stiles



North Andover door style in Cherry with Light stain

Wood Species *for Framed and Full Access Cabinetry*



Cherry



Hickory



Maple



Oak



Knotty Alder



Rustic Cherry



Rustic Hickory



Rustic Maple



Rustic Oak

When rustic species are chosen, the doors and drawer fronts are made from rustic wood and other components are made from normal wood.

When Knotty Alder is chosen, the doors, drawer fronts and finished plywood components are made from knotty wood and all other components are made from normal wood.

For cabinet doors, we use rustic/knotty wood for the center panels but normal wood for the framing.

The combination of rustic/knotty woods and normal woods allows the doors and cabinet boxes to be structurally sound, while still providing the rugged character of rustic and knotty woods.

Wood Finishes *for Framed and Full Access Cabinetry*

Samples of Stains, Base Coats and Paints

These samples are only a small example of the thousands of paints, stains and base coats available. See your Bishop dealer for more!

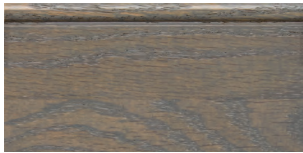

Driftwood stain on Oak



Medium stain on Cherry



Light stain on Maple



Dusk stain on Maple



Fog stain on Maple



Natural finish on Maple



Medium stain on Oak



Obsidian stain on Cherry



Natural finish on Birch



Obsidian stain on Birch



Custom base coat on Maple

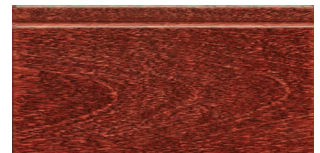

Pinot Noir stain on Birch



Dusk stain on Cherry

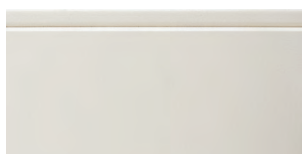

Nordic White paint on Maple



Light stain on Cherry



Custom base coat on Maple



Black paint on Maple



Fog stain on Oak



Driftwood stain on Cherry



Amber stain on Maple



Chestnut stain on Birch



Custom base coat on Maple



Offwhite base coat on Maple



Custom base coat on Maple

Wood Finishes *for Framed and Full Access Cabinetry*

Hand-Applied Finish Techniques

Add any combination of these techniques to stains or base coats to create one-of-a-kind Old World finishes!



Glaze (chocolate)
Shown on Offwhite base coat



Edgewear
Shown on Black base coat



Physical Distress
Shown on Brilliant White
base coat with Oyster glaze

Samples of Glazed Finishes



Light stain w/
Black glaze on
Cherry



Custom base coat
w/ Chocolate
glaze on Maple

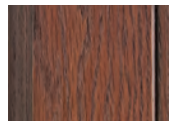

Pinot Noir stain
w/ Black glaze
on Oak



Custom base coat
w/ Chocolate
glaze on Maple



Natural finish
w/ Black glaze
on Oak

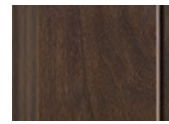

Obsidian stain w/
Chocolate glaze
on Cherry



Custom base coat
w/ Chocolate
glaze on Oak



Custom base coat
w/ Oyster glaze
on Maple



Offwhite base
coat w/ Oyster
glaze on Maple

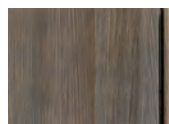

Driftwood stain
w/ Black glaze
on Cherry



Medium stain
w/ Mocha glaze
on Cherry



Offwhite base
coat w/ Oyster
glaze on Oak



Custom base coat w/
Oyster glaze Edge-
wear on Maple

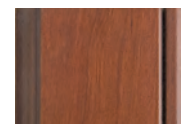

Custom stain
w/ Black glaze
on Cherry



Custom base coat
w/ Mocha glaze
on Oak



Light stain w/
Mocha glaze on
Maple



Offwhite base coat
w/ Chocolate
glaze on Maple



Natural finish w/
Black glaze on
Hickory

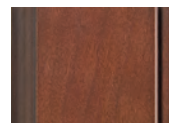

Pinot Noir stain
w/ Black glaze
on Cherry



Light stain w/
Oyster glaze on
Cherry



Amber stain w/
Chocolate glaze
on Maple

Custom Paints and Stains

Have you found a stain or paint color that you just can't live without? Our Custom Finish program may be just what you are looking for!

Your Bishop dealer can send a paint color number or a physical sample of the color to us and we will match it.



Foil Door Styles *for Full Access Cabinetry*

FR01, FR11



Line Name	Grain Direction
FR01	Vertical
FR11	Horizontal (shown)

Foil Category
Round

Foil Color Shown
Macassar Gloss

FR02, FR12



Line Name	Grain Direction
FR02	Vertical (shown)
FR12	Horizontal

Foil Category
Round

Foil Color Shown
Olive Gloss

FR03, FR13



Line Name	Grain Direction
FR03	Vertical (shown)
FR13	Horizontal

Foil Category
Round

Foil Color Shown
Carbon Gloss

FR04, FR14



Line Name	Grain Direction
FR04	Vertical (shown)
FR14	Horizontal

Foil Category
Round

Foil Color Shown
Cranberry Gloss

Foil Door Styles *for Full Access Cabinetry*

FR05, FR15



Line Name	Grain Direction
FR05	Vertical
FR15	Horizontal (shown)

Foil Category
Round

Foil Color Shown
Maria Rose Gloss

FF01, FF11

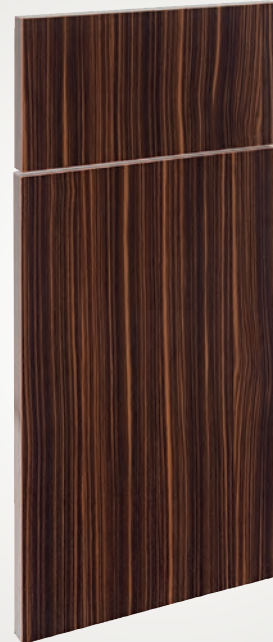

Line Name	Grain Direction
FF01	Vertical (shown)
FF11	Horizontal

Foil Category
Flat with matching or blending edgebanding

Foil Color Shown
Ebony Gloss

FF02, FF12

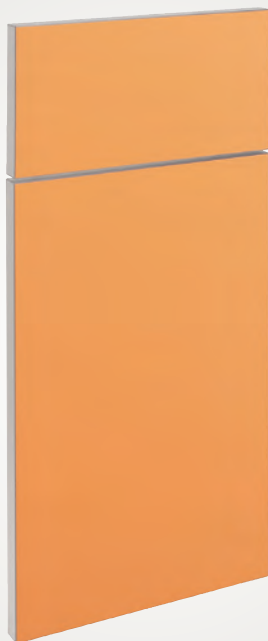

Line Name	Grain Direction
FF02	Vertical (shown)
FF12	Horizontal

Foil Category
Flat with Aluminum color Edgebanding

Foil Color Shown
Orange Gloss

FF03, FF13



Line Name	Grain Direction
FF03	Vertical (shown)
FF13	Horizontal

Foil Category
Flat with Steel color Edgebanding

Foil Color Shown
Black Gloss

Samples of Foil Colors



Black Acrylic



Blue Acrylic

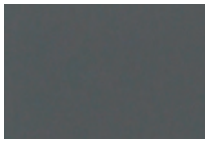

Dark Grey Acrylic



Fisherman's Wharf Tx



Grand Canyon Tx

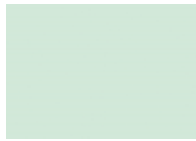

Grass Green Acrylic



Ivory Acrylic



King's Canyon Tx



Kona Tx



Linear Graphite



Malibu Tx



Outer Banks Tx



Oyster Bay Tx



Red HG



Royal Canyon Tx



Ruby Red Acrylic



Smoke Acrylic



White Acrylic

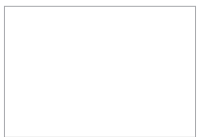

White HG

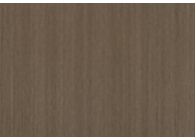

Wired Bronze



Wired Cobalt



Wired Mercury



FR01 door style with Olive Gloss foil

Specialty Mullion Doors *for Framed and Full Access Cabinetry*

If you are looking for something a little different to create a focal point, one of these specialty mullion doors with your favorite glass may be just what you are looking for. Even though our cabinetry is considered semi-custom, we still enjoy being able to offer truly high-end accent doors. In fact, these doors are so custom that you actually approve a shop drawing of each one before they are hand-made just for you.

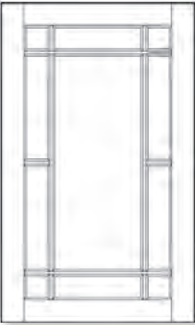

11 Lite Offset

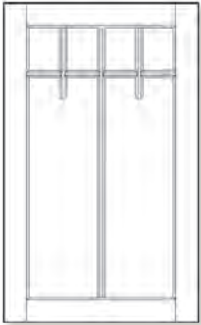

Odyssey

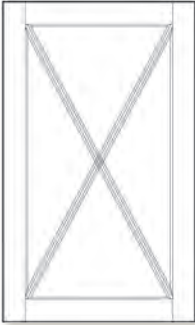

X Lite

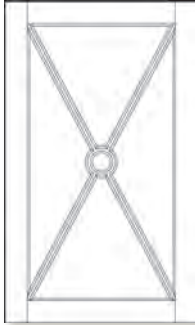

X Lite Solid Hub

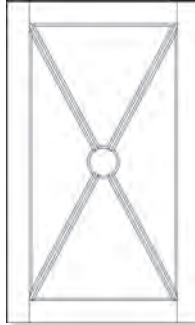

X lite Open Hub

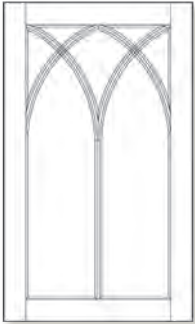

Arched Lite

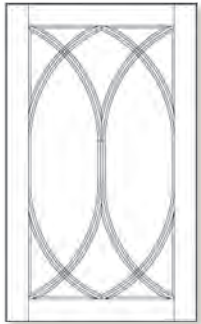

Double Arched Lite

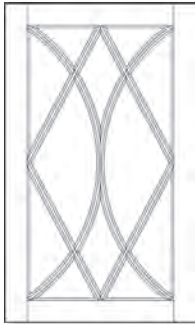

Double Box

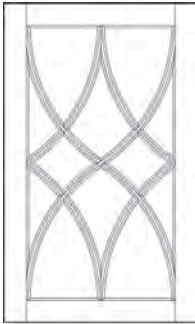

Hourglass Diamond

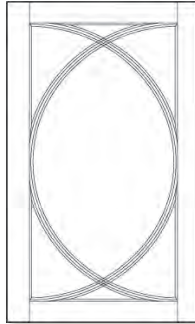

Vesica

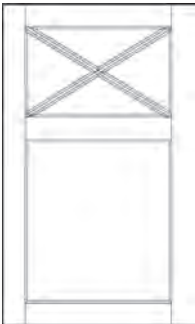

X Lite Panel

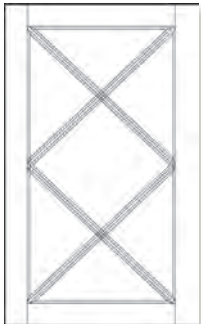

Double X

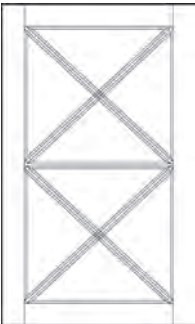

Double X Horizontal

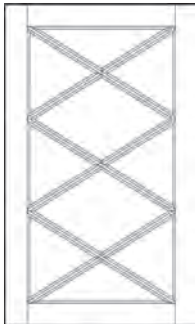

Triple X

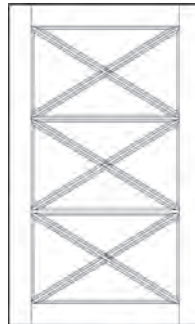

Triple X Horizontal

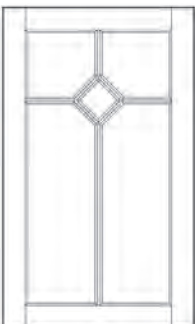

Diamond

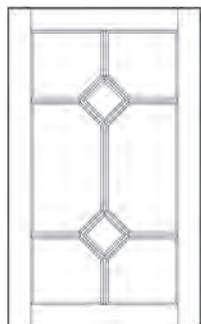

Double Diamond

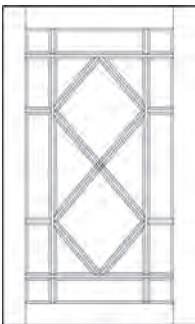

20 Lite
Double Diamond

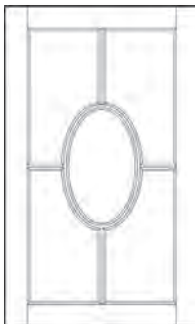

Elliptical

Accent Metal Doors *for Framed and Full Access Cabinetry*

Door Frames

Add a contemporary flair to your design by combining metal door frames with decorative inserts to create stunning accent doors!



M02
Aluminum finish (shown)
M02S
Brushed Stainless Steel finish



M03
Aluminum finish (shown)
M03S
Brushed Stainless Steel finish



M04
Aluminum finish (shown)
M04S
Brushed Stainless Steel finish



M05
Aluminum finish (shown)
M05S
Brushed Stainless Steel finish

Inserts for Metal Doors



Satin Glass



Reeded Glass

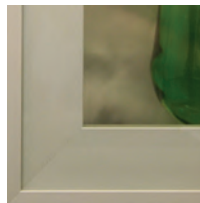

Clear Glass

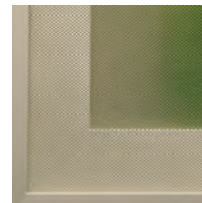

Listral D Glass

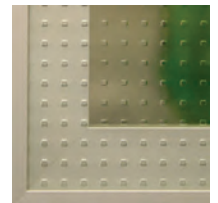

Master Carre Glass

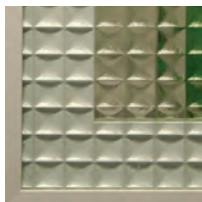

Austral Glass

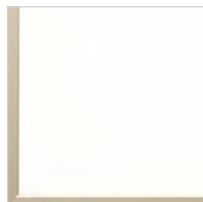

White Glass

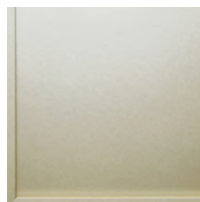

Platinum Ice Acrylic



Brushed Stainless Laminate



Aluminum Laminate

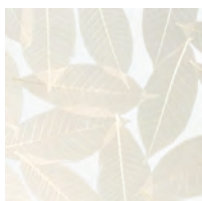

Fossil Leaves Resin

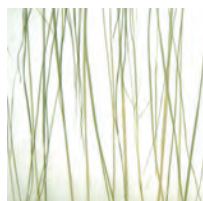

Beargrass Resin

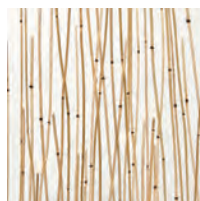

Thatch Resin



Linea Ivory Resin

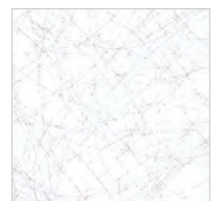

Wisp Silver Resin

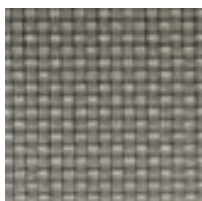

Quattro Carbon Resin

Framed Cabinet Boxes

The Basics Box

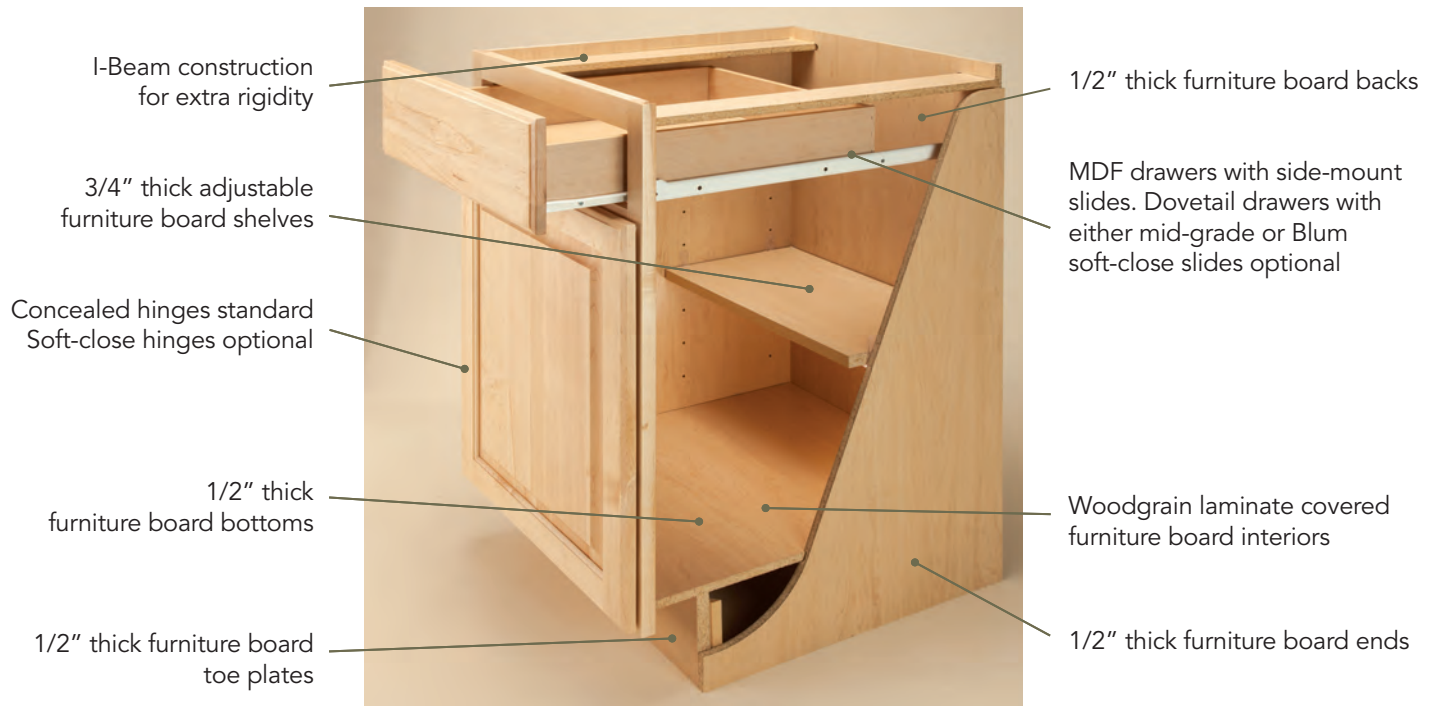

Birch and Maple styles available with limited finishes

The Standard Box

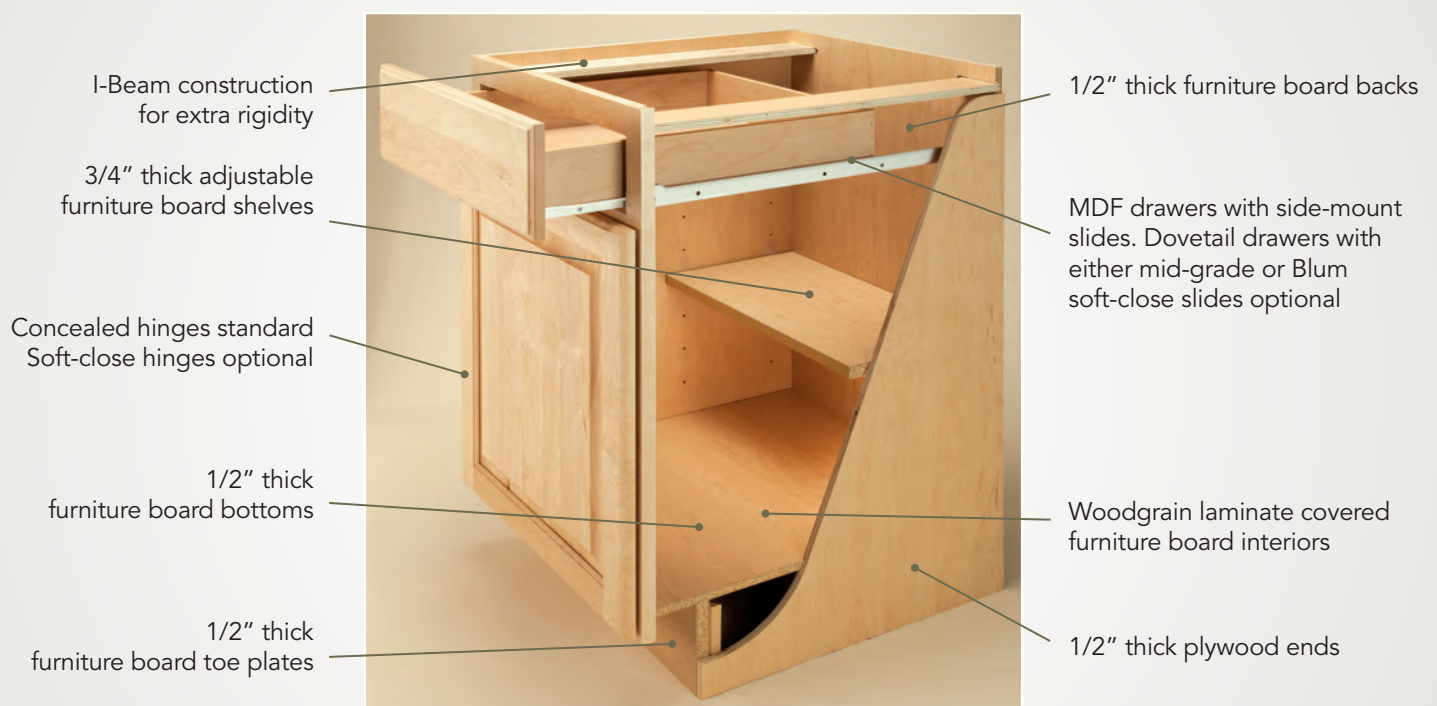

All species available

Framed Cabinet Boxes

The Deluxe Box

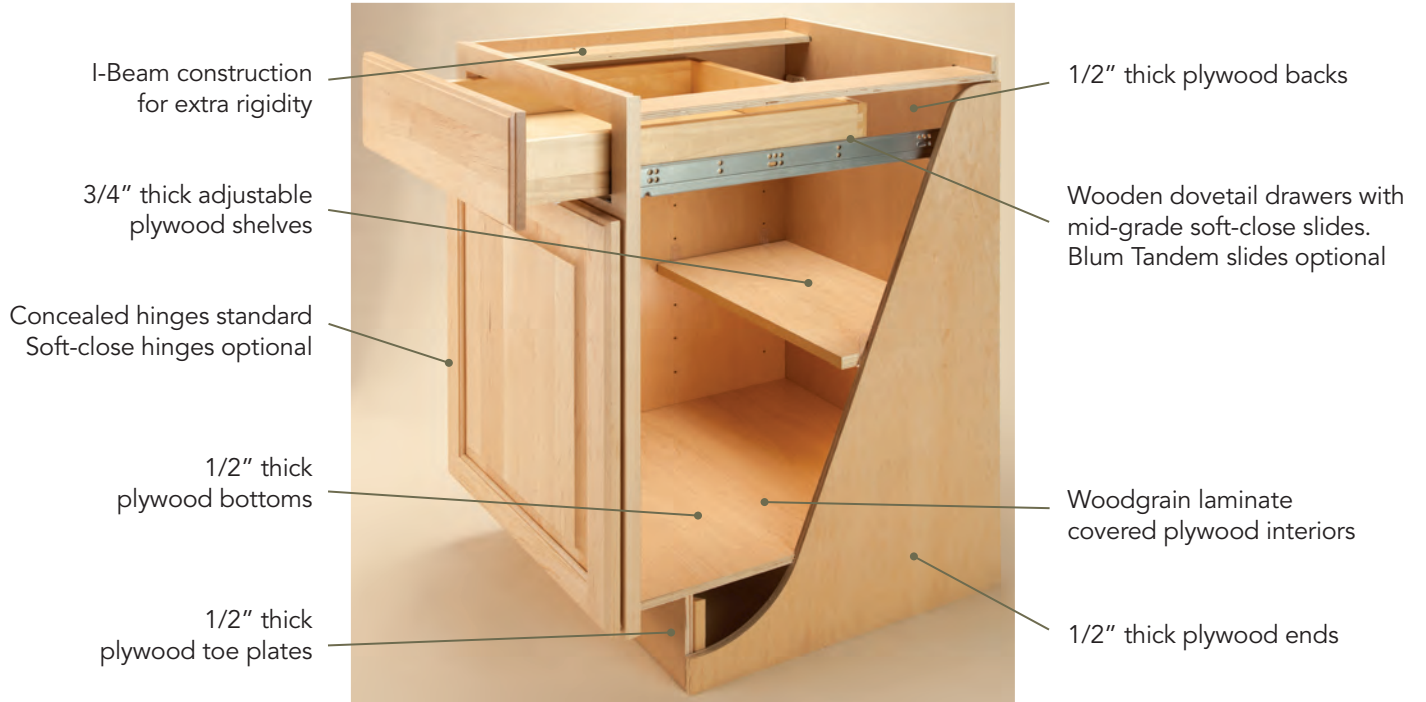

All species available

The Ultimate Box



All species available

Framed Cabinet Boxes/Drawer Options

The Paint Box



Maple and Birch wood species available only with painted or basecoat finishes

Drawer Options

Good



Fiber Drawer Box
Side Mount Epoxy Coated Slides

Better



Dovetailed Wood Drawer Box
Mid Grade Full Extension
Soft Close Slides

Best



Dovetailed Wood Drawer Box
Blum Tandem Full Extension
Soft Close Slides

Full Access Cabinet Boxes

The Woodgrain Box

3/4" thick furniture board stretchers in base and vanity cabinets

3/4" thick adjustable furniture board shelves

Self-close concealed hinges. Soft-close hinges optional for most cabinets

3/4" thick furniture board bottoms

3/4" thick furniture board toe plates

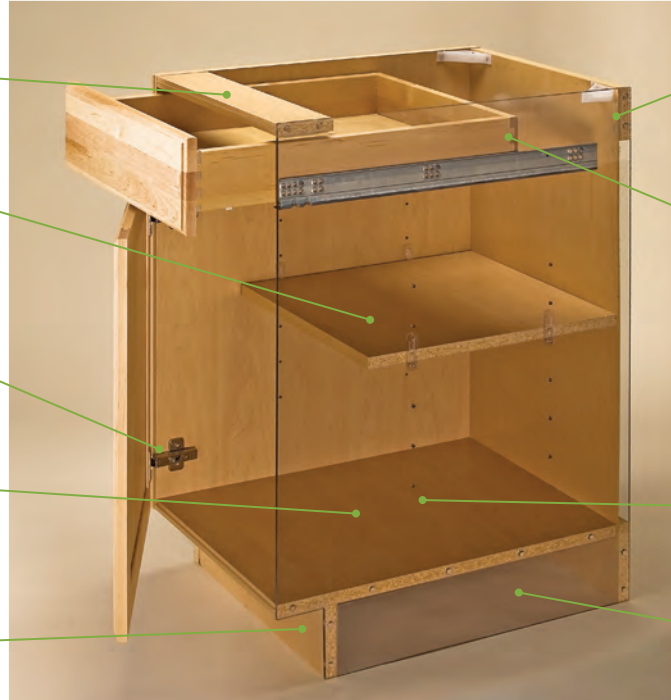

3/4" thick furniture board hanging rails and captive MDF backs

Dovetail drawers with midgrade slides. Dovetail drawers with Blum soft-close slides and Blum Tandembox drawers are optional

Woodgrain laminate covered furniture board interiors

3/4" thick furniture board ends

All species available

The White Box

3/4" thick furniture board stretchers in base and vanity cabinets

3/4" thick adjustable furniture board shelves

Self-close concealed hinges. Soft-close hinges optional for most cabinets

3/4" thick furniture board bottoms

3/4" thick furniture board toe plates



3/4" thick furniture board hanging rails and captive MDF backs

Dovetail drawers with midgrade slides. Dovetail drawers with Blum soft-close slides and Blum Tandembox drawers are optional

White laminate covered furniture board interiors

3/4" thick furniture board ends

Melamine and Foils only

Full Access Cabinet Boxes

The Deluxe Box

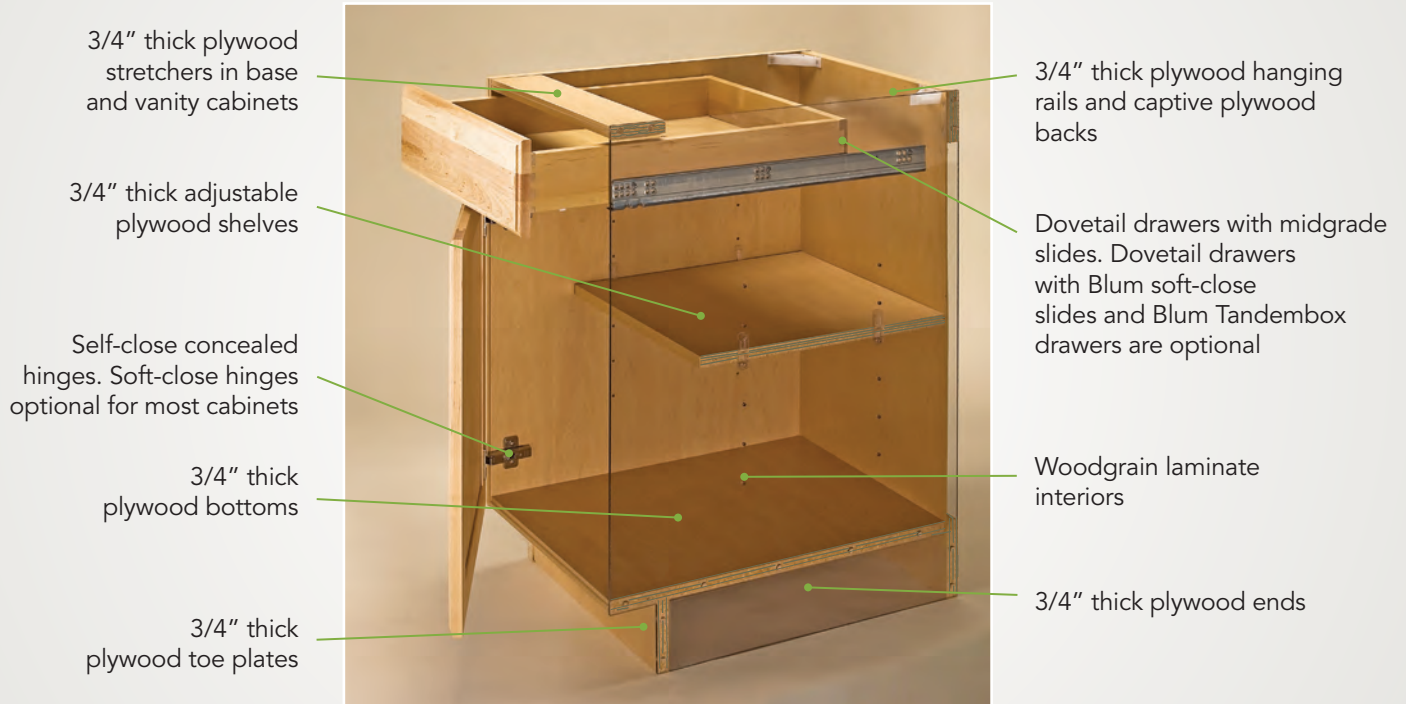

All species available

The Ultimate Box

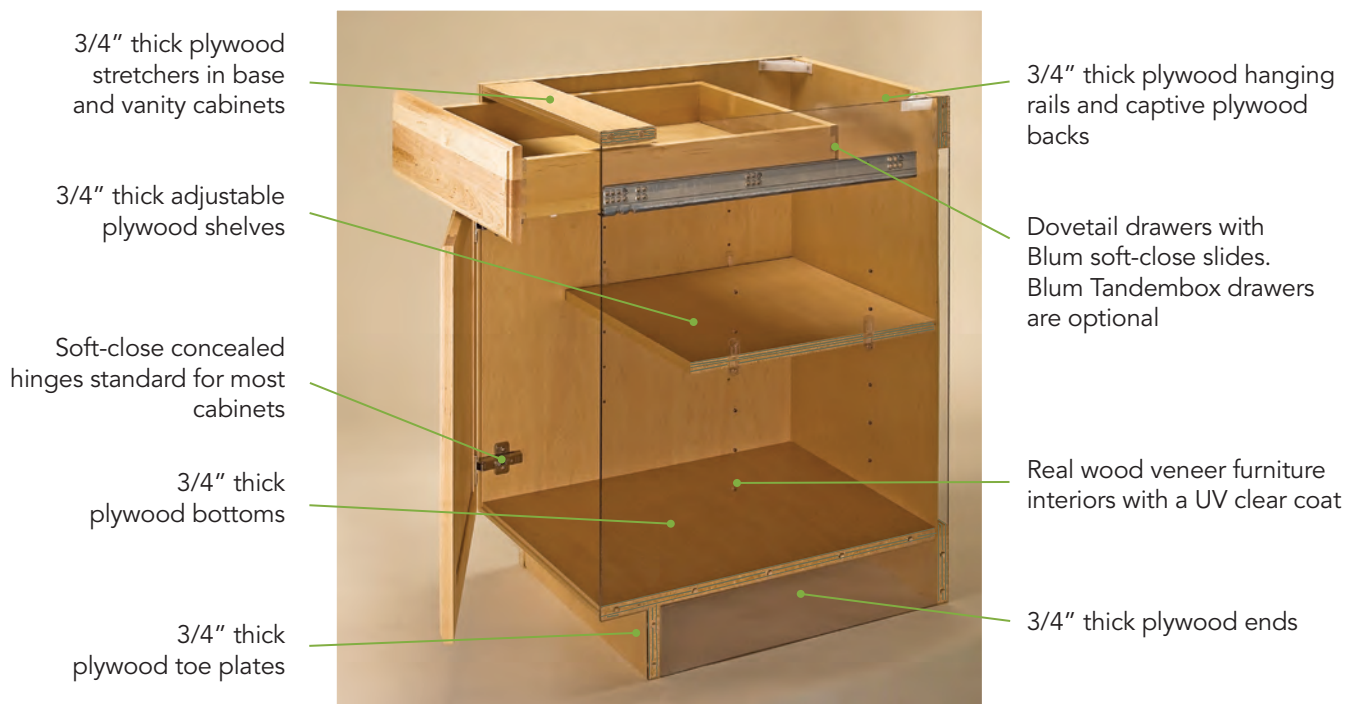

All species available

Full Access Drawer Options



- Dovetailed Wood Drawer Box
- Mid-Grade Full Extension
- Soft-Close Undermount Slides



- Dovetailed Wood Drawer Box
- Tandem with Blumotion Full Extension
- Soft-Close Undermount Slides



- Blum Tandembox with Blumotion
- Metal Sides with Integrated Concealed Slides
- Full-Extension Soft-Close



*Park City door style in Cherry with Cinnamon stain
Image compliments of Hinge Cabinetry*



*Kitchen: St Cloud door style in Maple with Brilliant White paint
Island: St Cloud door style in Maple with Black paint*



*New Ashford door style in Cherry with Chestnut stain
Image compliments of JK Design*



Long Beach door style in Maple with Custom Grey paint



Grand Isle door style in Maple with Fog stain



*FR01 door style with Maria Rose High Gloss foil
Image compliments of YR Supply*



*Kitchen: Ventura Way door style in Maple with Offwhite base coat and Mocha glaze
Bar area: Danbury door style in Maple with Amber stain and Mocha glaze
Island: Maple with custom finish
Image compliments of Anthony Slabaugh*



BISHOP CABINETS

5640 Bell Rd
Montgomery, AL 36116
www.bishopcabinets.com
800.410.2444
MADE IN THE USA

Your local Bishop dealer is:



Because printed media cannot accurately portray colors, tones and textures, a physical sample of the exact specie (where applicable), door style and color should be seen before making a final decision. Specifications noted herein are subject to change without notice.

August 2020

Essentials Collection

DOOR STYLE SELECTIONS





Home is our place for rest and comfort, for joy and memories. As we tailor our homes to suit the needs of our families, they become a reflection of who we are.

Because cabinetry is such an integral part of our homes, Bishop Cabinets makes each cabinet to order so that you can structure your living spaces to best suit your particular needs. But cabinetry is about more than just structure, it is also about beauty. The combinations of wood species, door styles and finishes that you will find within these pages will give you literally hundreds of thousands of possibilities, so that you can create that fashion which perfectly defines you.

In this booklet you'll find door styles from our Essentials Collection, which offers pre-designed door styles in many of today's most popular combinations.

The images shown on the following pages are only a small taste of those possibilities. After you've spent some time pondering what you might like, we invite you to visit your Bishop dealer to select your perfect style.

Birch

York

Slab



Wood Specie
Birch
Overlay
Full
Finish Shown
Pinot Noir stain
Doors
Square uppers
Square lowers
2" Stiles
Drawer Fronts
Slab shallow
Slab deep

Recessed Panel Square upper & lower doors
Available for Framed and Full Access Cabinetry

Petersburg

5 Piece



Wood Specie
Birch
Overlay
Full
Finish Shown
Light stain
Doors
Square uppers
Square lowers
2" Stiles
Drawer Fronts
5 Piece shallow
5 Piece deep

Recessed Panel Square upper & lower doors
Available for Framed and Full Access Cabinetry

Zermatt

Slab



Wood Specie
Birch
Overlay
Full
Finish Shown
Iron Paint
Doors
Square uppers
Square lowers
3" Stiles
Drawer Fronts
Slab shallow
Slab deep

Recessed Panel Square upper & lower doors
Available for Framed and Full Access Cabinetry

Utica

5 Piece



Wood Specie
Birch
Overlay
Full
Finish Shown
Offwhite base
coat with
Mocha glaze
Doors
Square uppers
Square lowers
3" Stiles
Drawer Fronts
5 Piece shallow
5 Piece deep

Recessed Panel Square upper & lower doors
Available for Framed and Full Access Cabinetry

Birch

Dallas

Slab



Wood Specie
Birch
Overlay
Full
Finish Shown
Natural finish
Doors
Veneer Slab uppers
Veneer Slab lowers
Drawer Fronts
Veneer Slab shallow
Veneer Slab deep

Slab upper & lower doors

Available for Framed and Full Access Cabinetry

Soho

Slab



Wood Specie
Birch
Overlay
Full
Finish Shown
Espresso stain
Doors
Veneer Slab uppers
Veneer Slab lowers
Drawer Fronts
Veneer Slab shallow
Veneer Slab deep
Includes integrated
pulls as shown

Slab upper & lower doors

Available for Framed and Full Access Cabinetry

Norfolk

Slab



Wood Specie
Birch
Overlay
1/2"
Finish Shown
Amber stain
Doors
Square uppers
Square lowers
2" Stiles
Drawer Fronts
Slab shallow
Slab deep
Veneer center
panels

Raised Panel Square upper & lower doors

Available for Framed Cabinetry

Springfield

Slab



Wood Specie
Birch
Overlay
1/2"
Finish Shown
Chestnut stain
Doors
Square uppers
Square lowers
2" Stiles
Drawer Fronts
Slab shallow
Slab deep

Recessed Panel Square upper & lower doors

Available for Framed Cabinetry

Birch

Lauderdale

5 Piece



Wood Specie
Birch
Overlay
Full
Finish Shown
Light stain with
Chocolate glaze
Doors
Square uppers
Square lowers
2 1/4" Stiles
Drawer Fronts
5 piece shallow
5 piece deep

Recessed Panel Square upper & lower doors
Available for Framed Cabinetry

Charleston

Slab



Wood Specie
Birch
Overlay
Full
Finish Shown
Obsidian stain
Doors
Square uppers
Square lowers
2 1/4" Stiles
Drawer Fronts
Slab shallow
Slab deep

Recessed Panel Square upper & lower doors
Available for Framed Cabinetry



*Danbury door style in Maple with Brilliant White paint
Image compliments of Main Line Kitchen Design*

Birch

Greenbriar

5 Piece



Wood Specie
Birch
Overlay
Full
Finish Shown
Nordic White
base coat with
Mocha glaze
Doors
Square uppers
Square lowers
2" Stiles
Drawer Fronts
5 Piece shallow
5 Piece deep
Veneer center
panels

Raised Panel Square upper & lower doors
Available for Framed Cabinetry

Fargo

Slab



Wood Specie
Birch
Overlay
Full
Finish Shown
Ellie Gray Paint
Doors
Square uppers
Square lowers
2" Stiles
Drawer Fronts
Slab shallow
Slab deep
Veneer center
panels

Raised Panel Square upper & lower doors
Available for Framed Cabinetry

Asheville

5 Piece



Wood Specie
Birch
Overlay
Full
Finish Shown
Custom paint color
Doors
Square uppers
Square lowers
2 1/4" Stiles
Drawer Fronts
5 Piece shallow
5 Piece deep
Veneer center
panels

Raised Panel Square upper & lower doors
Available for Framed Cabinetry

Rutland

Slab



Wood Specie
Birch
Overlay
Full
Finish Shown
Natural finish
Doors
Square uppers
Square lowers
2 1/4" Stiles
Drawer Fronts
Slab shallow
Slab deep
Veneer center
panels

Raised Panel Square upper & lower doors
Available for Framed Cabinetry

Paint Grade

Juneau

5 Piece



Wood Specie
Maple Frames
MDF panels
Overlay
Full
Finish Shown
Putty paint
Doors
Square uppers
Square lowers
2 1/2" Stiles
Drawer Fronts
5 Piece shallow
5 Piece deep

Recessed Panel Square upper & lower doors
Available for Framed and Full Access Cabinetry

Kirkwood

Slab

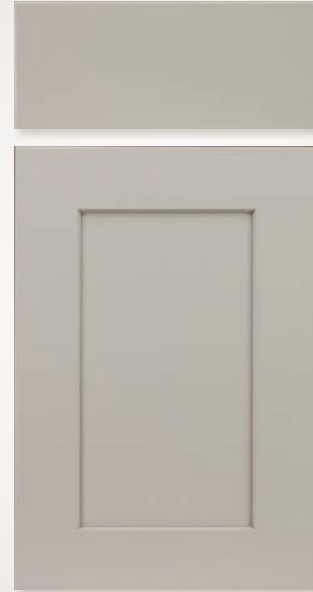

Wood Specie
Maple Frames
MDF panels
Overlay
Full
Finish Shown
Ellie Grey Paint
Doors
Square uppers
Square lowers
2 1/2" Stiles
Drawer Fronts
Slab shallow
Slab deep

Recessed Panel Square upper & lower doors
Available for Framed and Full Access Cabinetry



Danbury door style with Custom White Paint
Image compliments Hamby's Kitchen Center

Maple

Bridgehaven

5 Piece



Wood Specie
Maple
Overlay
Full
Finish Shown
Chalk base coat
with Oyster glaze
Doors
Square uppers
Square lowers
2 1/4" Stiles
Drawer Fronts
5 Piece shallow
5 Piece deep

Raised Panel Square upper & lower doors
Available for Framed Cabinetry

Martinique

Slab



Wood Specie
Maple
Overlay
Full
Finish Shown
Pinot Noir stain
Doors
Square uppers
Square lowers
2 1/4" Stiles
Drawer Fronts
Slab shallow
Slab deep

Raised Panel Square upper & lower doors
Available for Framed Cabinetry

Danbury

5 Piece



Wood Specie
Maple
Overlay
Full
Finish Shown
Chestnut stain
Doors
Square uppers
Square lowers
2 1/8" Stiles
Drawer Fronts
5 Piece shallow
5 Piece deep

Reversed Raised Panel Square upper & lower doors
Available for Framed Cabinetry

Quakerstown

Slab



Wood Specie
Maple
Overlay
Full
Finish Shown
Custom paint
Doors
Square uppers
Square lowers
2 1/8" Stiles
Drawer Fronts
Slab shallow
Slab deep

Reversed Raised Panel Square upper & lower doors
Available for Framed Cabinetry

Maple

Oak

Thomaston

5 Piece



Wood Specie
Maple

Overlay
Full

Finish Shown
Natural finish

Doors
Square uppers
Square lowers
2 1/8" Stiles

Drawer Fronts
5 Piece shallow
5 Piece deep

Reverse Raised Panel Square upper & lower doors with Center Battens applied to wider doors

Available for Framed Cabinetry

Essex

Slab

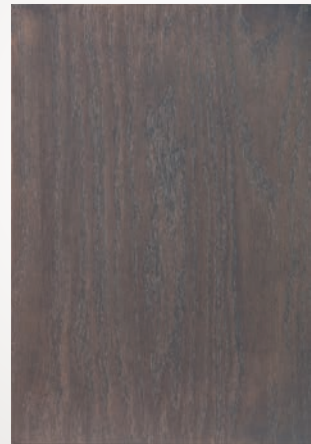
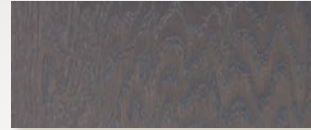

Wood Specie
Oak Veneer

Overlay
Full

Finish Shown
Dusk Stain

Doors
Slab uppers
Slab lowers

Drawer Fronts
Slab shallow
Slab deep

Slab upper & lower doors

Available for Framed and Full Access Cabinetry



Petersburg door style mixing paint with stain
Image courtesy of Oread Design

Endless Choices

Our Essentials collection consists of Hard Maple, Birch, and Oak wood species. Each species contains many distinguishing characteristics that affect its overall beauty and final finished look. During the planning stages of your new kitchen, it is vitally important to review exact samples of the wood and finish combinations you are considering. The unique characteristics of these species will cause the same applied finishes and techniques to be beautifully different in many ways.

Depending on your desired delivery date, we have many options for you to choose from when it comes to finish. We offer standard stains, paints, and specialty techniques in a standard lead-time. Or, if your project has more flexibility in time and your desired finishes are custom, we have endless choices available in our custom paint, custom stain, and non-standard finish programs. Please consult with your dealer during the planning phase of your project for a full explanation of our lead times, available finishes, and door style options.



*Utica door style with two paint colors
Image courtesy of Main Line Kitchen Design*

Wood Finishes

Samples of Stains, Base Coats and Paints

These samples are only a small example of the thousands of paints, stains and base coats available. See your Bishop dealer for more!

**See page 10 for custom finish options.*

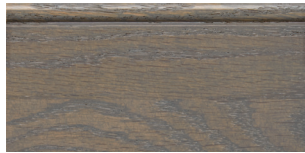

Driftwood stain on Oak



Medium stain on Cherry



Light stain on Maple



Dusk stain on Maple



Fog stain on Maple



Natural finish on Maple



Medium stain on Oak



Obsidian stain on Cherry



Natural finish on Birch



Obsidian stain on Birch



*Custom base coat on Maple

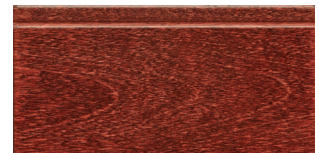

Pinot Noir stain on Birch



Dusk stain on Cherry



Nordic White paint on Maple



Light stain on Cherry



*Custom base coat on Maple



Black paint on Maple



Fog stain on Oak



Driftwood stain on Cherry



Amber stain on Maple



Chestnut stain on Birch



*Custom base coat on Maple



Offwhite base coat on Maple



*Custom base coat on Maple

Wood Finishes

Hand-Applied Finish Techniques

Add any combination of these techniques to stains or base coats to create one-of-a-kind Old World finishes!



Glaze (chocolate)
Shown on Offwhite base coat



Edgewear
Shown on Black base coat



Physical Distress
Shown on Brilliant White
base coat with Oyster glaze

Samples of Glazed Finishes



Light stain w/
Black glaze on
Cherry



Custom base coat
w/ Chocolate
glaze on Maple

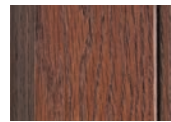

Pinot Noir stain
w/ Black glaze
on Oak



Custom base coat
w/ Chocolate
glaze on Maple



Natural finish
w/ Black glaze
on Oak

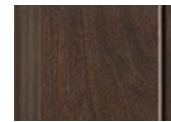

Obsidian stain w/
Chocolate glaze
on Cherry



Custom base coat
w/ Chocolate
glaze on Oak



Custom base coat
w/ Oyster glaze
on Maple



Natural finish w/
Oyster glaze on
Cherry



Driftwood stain
w/ Black glaze
on Cherry



Medium stain
w/ Mocha glaze
on Cherry

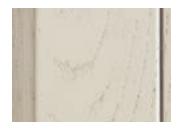

Offwhite base
coat w/ Oyster
glaze on Oak



Cinnamon stain
w/ Black glaze
on Cherry

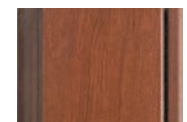

Custom stain
w/ Black glaze
on Cherry



Custom base coat
w/ Mocha glaze
on Oak



Light stain w/
Mocha glaze on
Maple



Offwhite base coat
w/ Chocolate
glaze on Maple

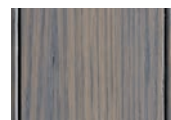

Driftwood stain
w/ Black glaze on
Oak

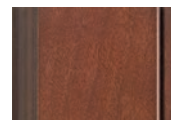

Pinot Noir stain
w/ Black glaze
on Cherry



Iron base coat w/
Black glaze on
Maple



Amber stain w/
Chocolate glaze
on Maple

Custom Paints and Stains

Have you found a stain or paint color that you just can't live without? Our Custom Finish program may be just what you are looking for!

Your Bishop dealer can send a paint color number or a physical sample of the color to us and we will match it.



Melamine Door Styles

Elegante

Slab

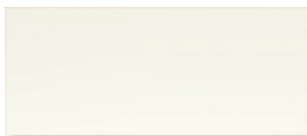

Laminate
High Gloss
Melamine
Color
Blanco
Doors
Slab Uppers
Slab Loweres
Drawer Fronts
Slab Shallow
Slab Deep

Slab Upper & Lower Doors

Available for Full Access Cabinetry

Yosemite

Slab



Laminate
Textured
Melamine
Color
City Oak
Doors
Slab Uppers
Slab Loweres
Drawer Fronts
Slab Shallow
Slab Deep

Slab Upper & Lower Doors

Available for Full Access Cabinetry

Velluto

Slab

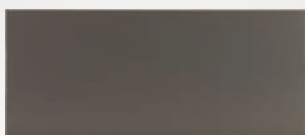

Laminate
Ultra Matte
Melamine
Color
Antracita
Doors
Slab Uppers
Slab Loweres
Drawer Fronts
Slab Shallow
Slab Deep

Slab Upper & Lower Doors

Available for Full Access Cabinetry

Yosemite textured colors available

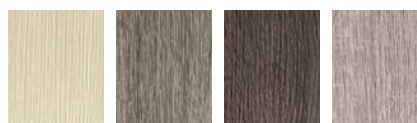

Oregon Pine City Oak Aspen Oak Barn Oak

Elegante high gloss colors available



Blanco Antracita Euroline 03

Velluto ultra matte colors available



Antracita

Framed Cabinet Boxes

The Basics Box

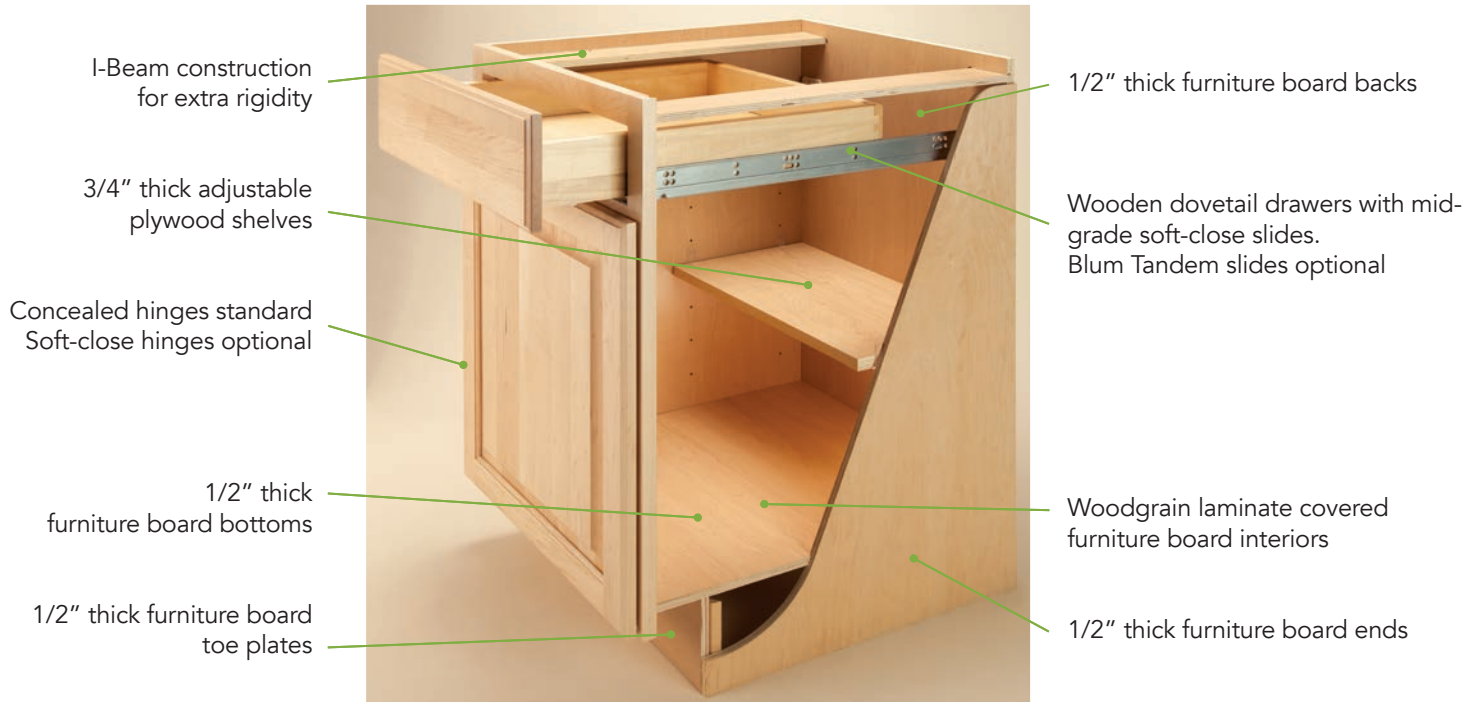

The Standard Box

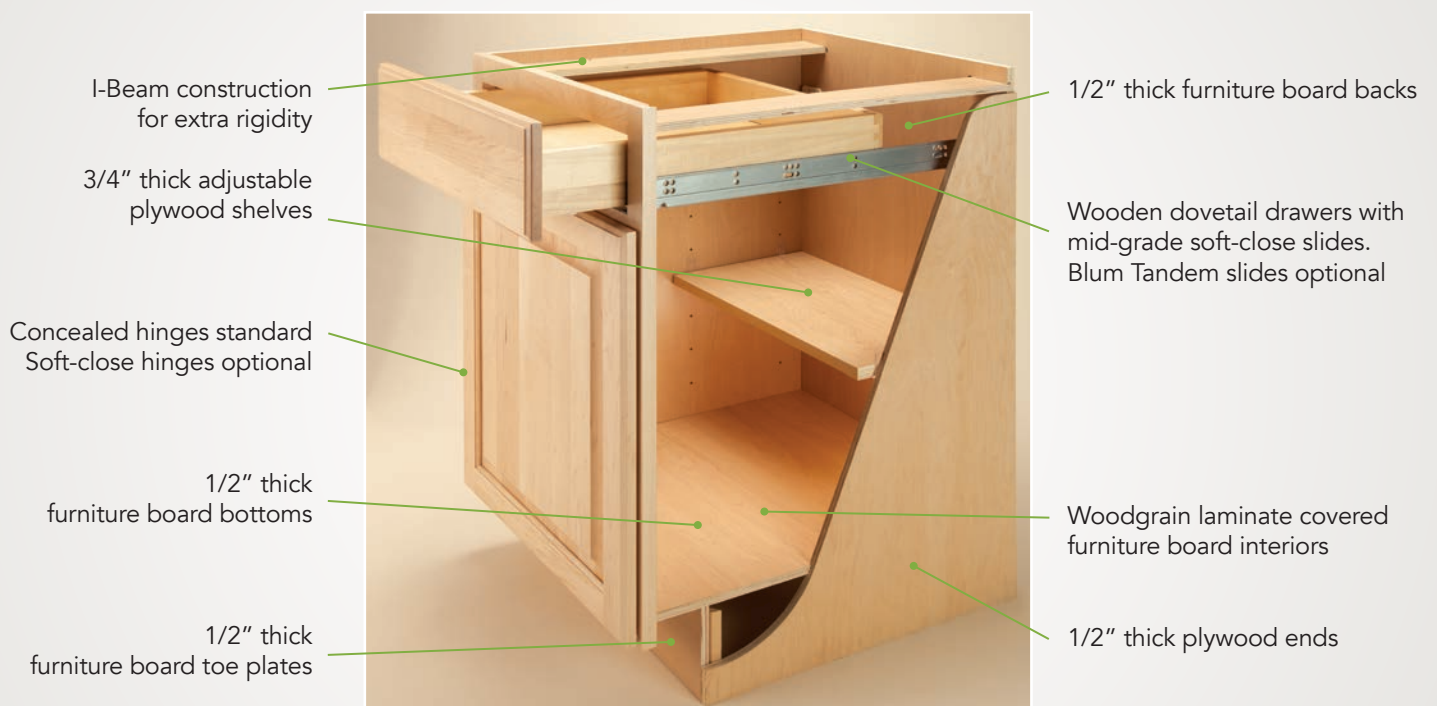

Framed Cabinet Boxes

The Deluxe Box

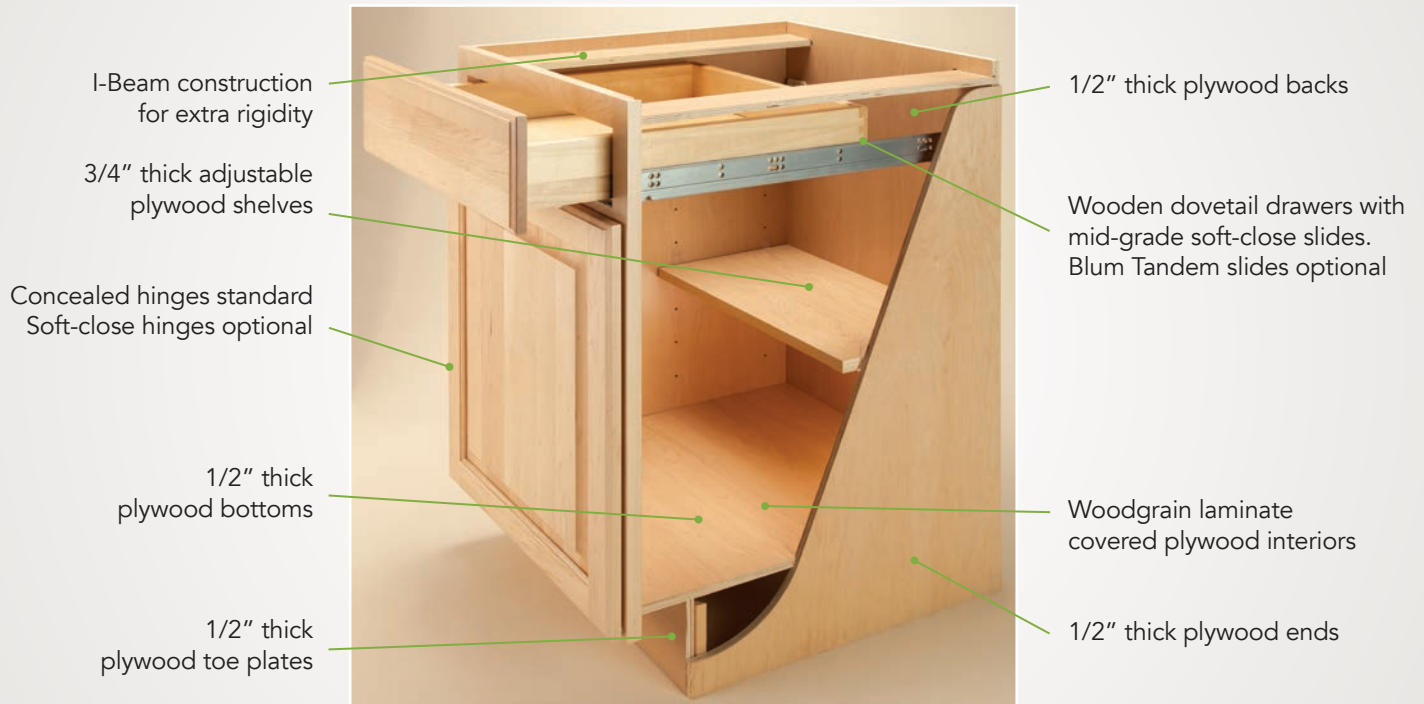

The Ultimate Box



Framed Cabinet Boxes

The Paint Box

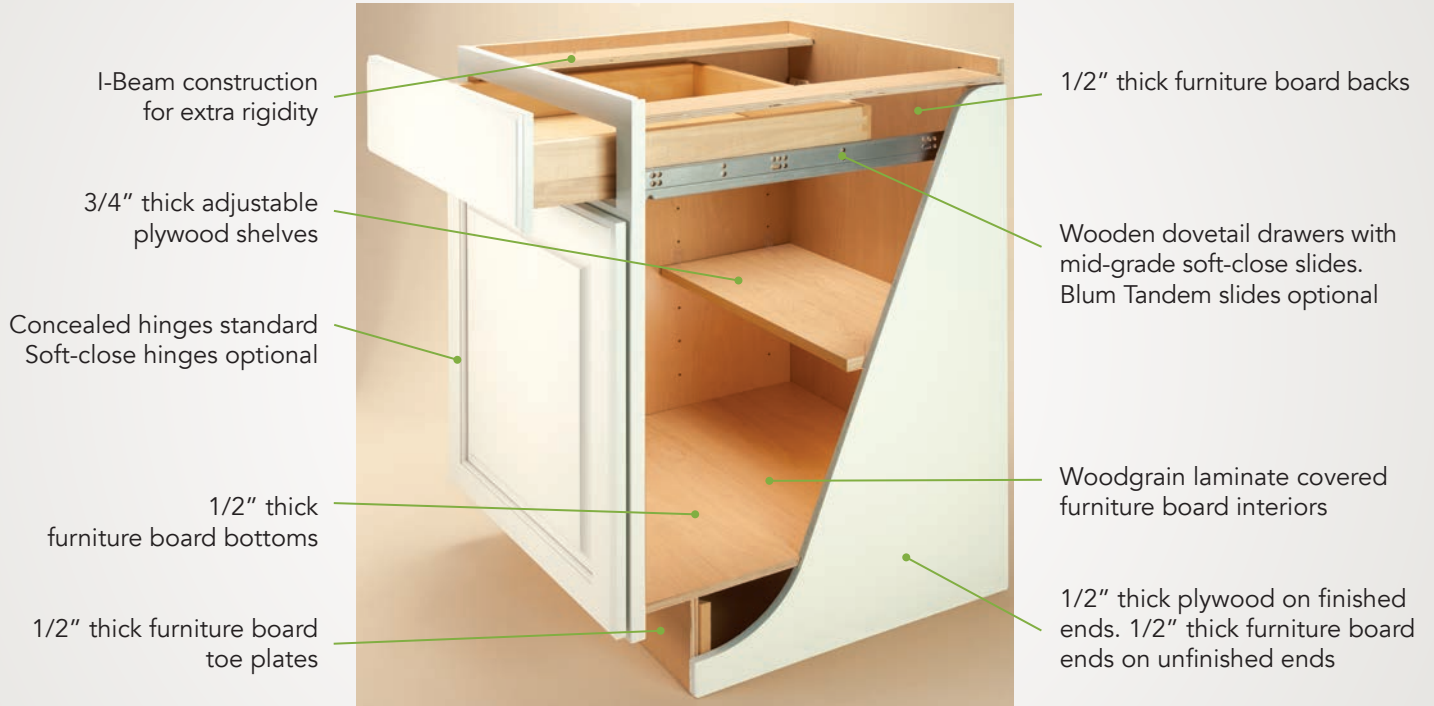

Drawer Options

Good



Dovetailed Wood Drawer Box
Soft-close mid-grade slides

Better



Dovetailed Wood Drawer Box
Blum Tandem full extension
Soft-close slides

Full Access Cabinet Boxes

The Woodgrain Box

3/4" thick furniture board stretchers in base and vanity cabinets

3/4" thick adjustable plywood shelves

Soft-close hinges

3/4" thick furniture board bottoms

3/4" thick furniture board toe plates

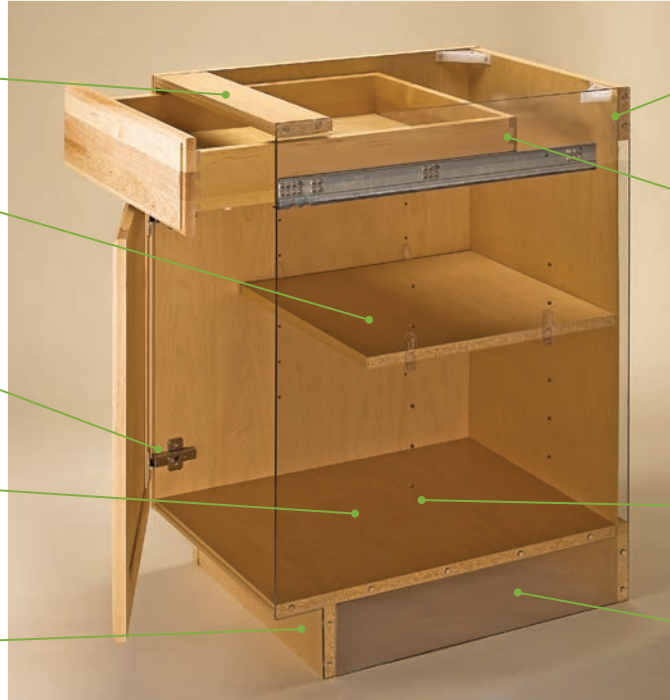

3/4" thick furniture board hanging rails and captive MDF backs

Dovetail drawers with Blum soft-close slides. Blum Tandembox drawers are optional

Woodgrain laminate covered furniture board interiors

3/4" thick furniture board ends

The White Box

3/4" thick furniture board stretchers in base and vanity cabinets

3/4" thick adjustable furniture board shelves

Soft-close hinges

3/4" thick furniture board bottoms

3/4" thick furniture board toe plates



3/4" thick furniture board hanging rails and captive MDF backs

Dovetail drawers with Blum soft-close slides. Blum Tandembox drawers are optional

White laminate covered furniture board interiors

3/4" thick furniture board ends

Full Access Cabinet Boxes

The Deluxe Box

3/4" thick plywood stretchers in base and vanity cabinets

3/4" thick adjustable plywood shelves

Soft-close hinges

3/4" thick plywood bottoms

3/4" thick plywood toe plates

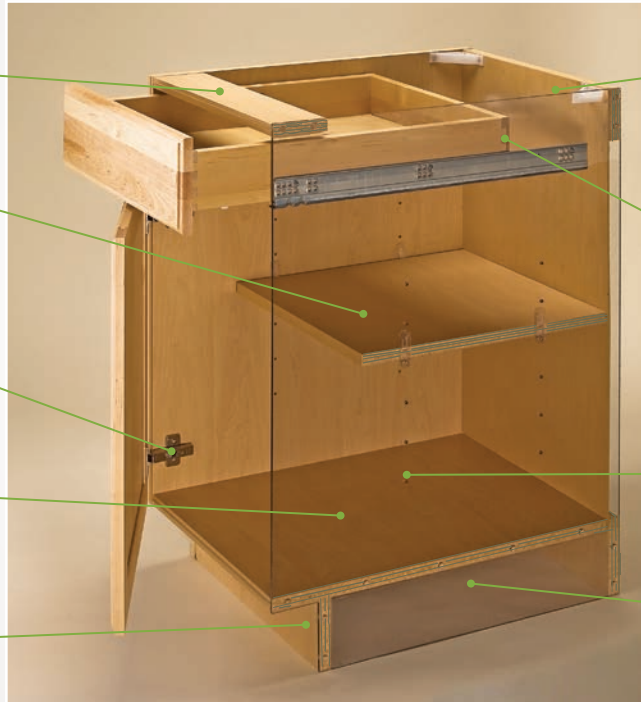

3/4" thick plywood hanging rails and captive plywood backs

Dovetail drawers with Blum soft-close slides. Blum Tandembox drawers are optional

Woodgrain laminate interiors

3/4" thick plywood ends

The Ultimate Box

3/4" thick plywood stretchers in base and vanity cabinets

3/4" thick adjustable plywood shelves

Soft-close concealed hinges standard for most cabinets

3/4" thick plywood bottoms

3/4" thick plywood toe plates

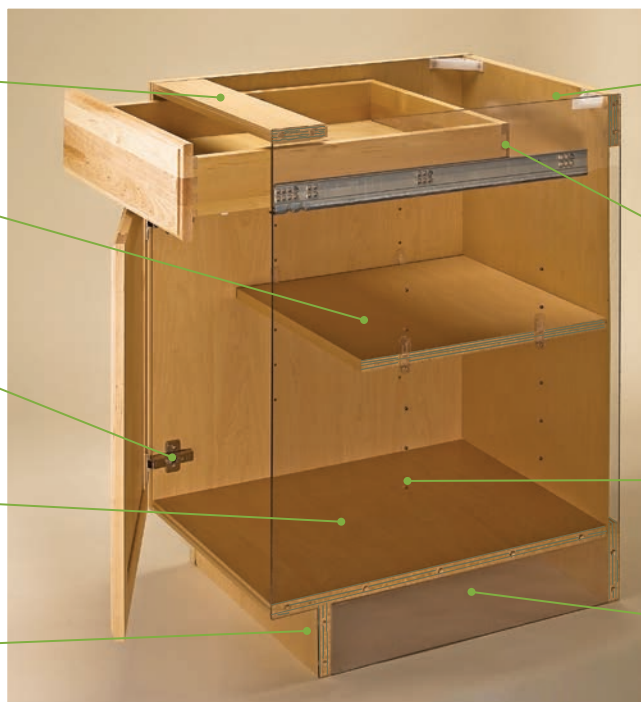

3/4" thick plywood hanging rails and captive plywood backs

Dovetail drawers with Blum soft-close slides. Blum Tandembox drawers are optional

Real wood veneer furniture interiors with a UV clear coat

3/4" thick plywood ends

Full Access Drawer Options



Wood Dovetail Drawers and Tandem with Blumotion Drawer Slides



Blum Tandembox with Blumotion



Ashevile door style with Natural finish. Image compliments of Adams Interiors.



Soho door style with Espresso stain



5640 Bell Rd
Montgomery, AL 36116
www.bishopcabinets.com
800.410.2444
MADE IN THE USA

Your local Bishop dealer is:



Because printed media cannot accurately portray colors, tones and textures, a physical sample of the exact specie (where applicable), door style and color should be seen before making a final decision. Specifications noted herein are subject to change without notice.

September 2022